



Axelent **X-Protect**

PRODUCT RANGE & TECHNICAL SPECIFICATIONS



12

Your safety is our mission since 1990

Axelent is a complete supplier of safety for production, warehouses, and properties. Our mission is that all employees should have a safe working environment.

Today, we are one of the largest suppliers of safety solutions for the industry and most of our employees are located at the head office in Hillerstorp, Sweden, where all our products are developed and manufactured.

Axelent X-Protect

- 2. Content & Axelent
- 3. X-Protect
- 6. Bollards & X-Guard Connection
- 8. Impact Barriers
- 16. Pedestrian + Impact Barriers



Towards a sustainable future

Continual improvement and smart solutions are central to Axelent's sustainability work.

With a strategy entailing continual development and renewal, we aim to reduce our environmental impact in all areas of operations.



More information at
WWW.AXELENT.COM

Protection designed for a simple future

X-Protect is a unique approach to safety barriers. Unrivalled modularity, using only a few system components and damping that is built in to create a barrier system that changes with your work place. X-Protect allows rapid transformation, repair or replacement of existing barriers and bespoke configurations are limitless.

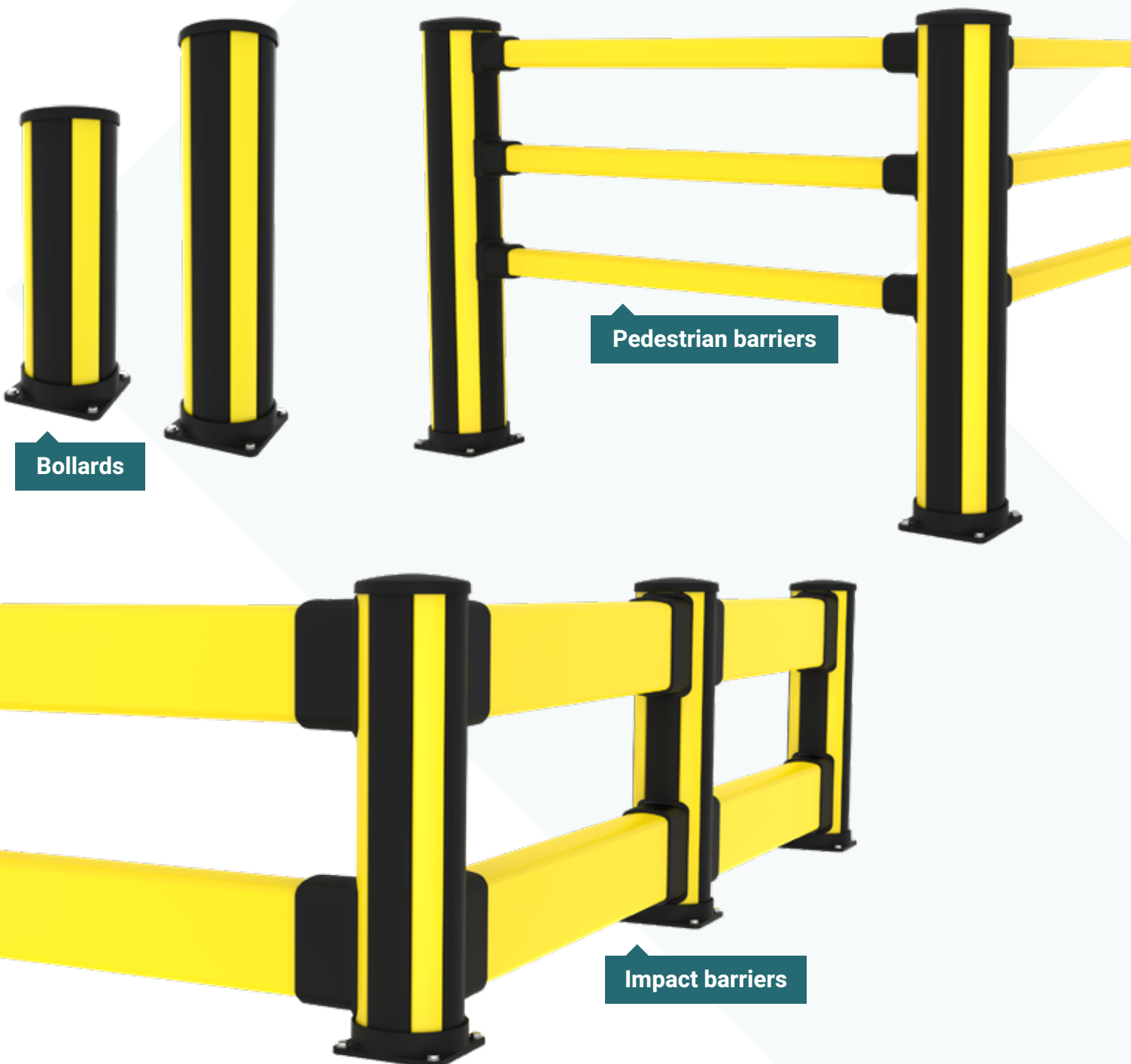



Assembly

X-Protect is **incredibly easy to assemble and dis-assemble** with minimal tools.



SCAN THE CODE TO
DOWNLOAD OUR
ASSEMBLY MANUALS

Environment

Sustainability is at the forefront of our minds. **Only one kind of plastic is used in each part, which makes the product optimal for recycling.** When it is worn out, you can simply recycle the material.

It also **allows for damaged or worn parts to be replaced at a component level.** The materials are the result of careful choices, all to make X-Protect as long-lived and environmentally friendly as possible.



Packaging

All X-Protect components have been **designed with packing efficiency in mind**, so that space is optimised.

Furthermore, we use our **X-Pack** packing philosophy so the parts you need are on hand and installations can start quickly.

Impact testing

We conduct hundreds of tests at our state-of-the-art testing facility every year. Using a weighted forklift truck replica, we can apply **repeatable real-world forces to impact zones**.

For further information on our testing methods or detailed test reports please contact your Axelent representative.



YOU CAN READ ABOUT THE TEST RESULTS FOR EACH CONFIGURATION ON THEIR RESPECTIVE PAGES, BEGINNING ON PAGE 6.

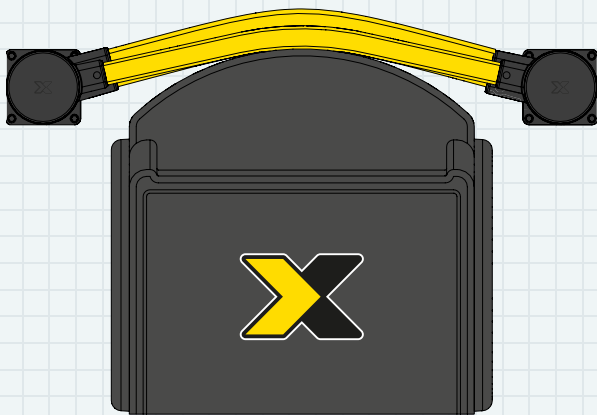



Bollards

When should you use the X-Protect Bollards?

✔ Use our X-Protect bollards to protect doorways, exposed corners and machinery. The black and yellow bollards also attract the fork lift driver's attention and act as guidance along traffic routes.

SCAN THE CODE TO WATCH OUR ASSEMBLY VIDEO

⚠ Our **weighted forklift truck replica**, applies repeatable real-world forces to impact zones.



IMPACT TEST RESULTS			
Bollard height	Load	90° Deflection	Force to fixings
350mm	3200 J	NA*	18 kN
610mm	5250 J	300mm	19.5 kN
870mm	5250 J	420mm	17.5 kN
1160mm	5250 J	620mm	12 kN

* Due to the bollard height, it is considered that the deflection is not critical for product selection.

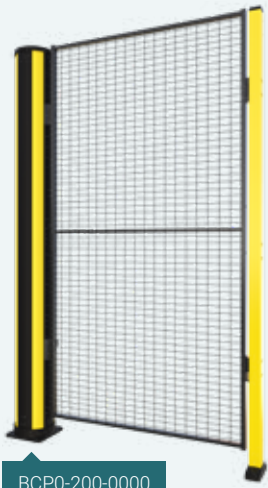

BCP0-200-0000

X-Guard compatible bollards

✓ If you have our machine guard system X-Guard installed, it is easy to integrate it with our X-Protect range. This taller bollard comes in three heights to fit our most common panel options. Following on from the bollard you can then choose any configuration of X-Protect.*

* Please consult with your Axelent representative for correct usage.

X-Guard

Our machine guard system X-Guard comes with a wide range of standard components and accessories. It is guaranteed to cover all of your machine guard needs.



SCAN THE CODE TO LEARN MORE ABOUT X-GUARD

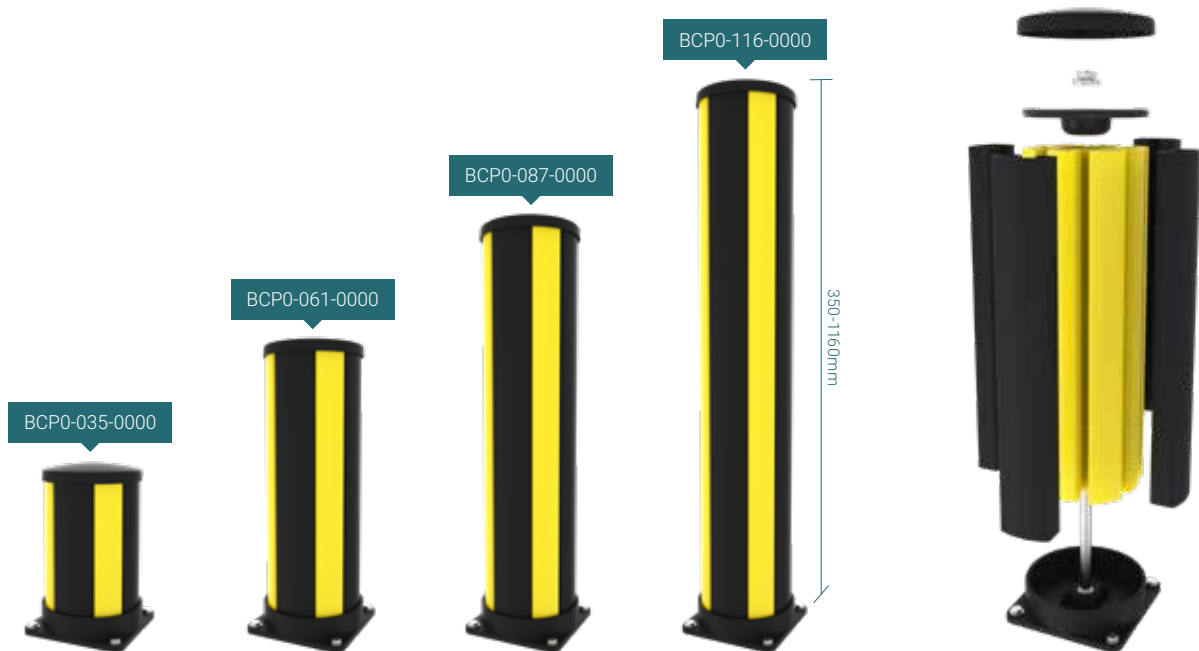

ARTICLES FOR BOLLARDS & X-GUARD CONNECTION

Art.No.	Product name	Colour
Bollards		
BCP0-116-0000	Bollard, H=1160mm W=200mm	● RAL 1018 & ● RAL 9011
BCP1-116-0000	Bollard, H=1160mm W=200mm	● RAL 1018
BCP0-087-0000	Bollard, H=870mm W=200mm	● RAL 1018 & ● RAL 9011
BCP1-087-0000	Bollard, H=870mm W=200mm	● RAL 1018
BCP0-061-0000	Bollard, H=610mm W=200mm	● RAL 1018 & ● RAL 9011
BCP1-061-0000	Bollard, H=610mm W=200mm	● RAL 1018
BCP0-035-0000	Bollard, H=350mm W=200mm	● RAL 1018 & ● RAL 9011
BCP1-035-0000	Bollard, H=350mm W=200mm	● RAL 1018
X-Guard Connection (tall bollards)		
BCP0-230-0000	Bollard, H=2300mm W=200mm	● RAL 1018 & ● RAL 9011
BCP1-230-0000	Bollard, H=2300mm W=200mm	● RAL 1018
BCP0-200-0000	Bollard, H=2000mm W=200mm	● RAL 1018 & ● RAL 9011
BCP1-200-0000	Bollard, H=2000mm W=200mm	● RAL 1018
BCP0-140-0000	Bollard, H=1400mm W=200mm	● RAL 1018 & ● RAL 9011
BCP1-140-0000	Bollard, H=1400mm W=200mm	● RAL 1018

* Please consult the assembly manual for the complete list of all articles. Scan the QR code on page 4 to download it.



Impact

When should you use the Impact Barrier?

✓ Use the Impact Barrier for ground level impact protection. It is ideal for segregating light weight vehicles or defining warehouse zones.

SCAN THE CODE TO WATCH OUR ASSEMBLY VIDEO

Our **weighted forklift truck replica**, applies repeatable real-world forces to impact zones.



IMPACT TEST RESULTS

Area of impact	Load	90° Deflection	Force to fixings
Centre of barrier C-C as below			
2500mm	4200 J	390mm	<14 kN
3000mm	3900 J	420mm	<14 kN
Posts			
End post	4500 J	<390mm *	<14 kN
Mid post	4500 J	<390mm *	<14 kN

* Deflection of posts is significantly less than that of the rail/s and is not considered to be critical for product selection.

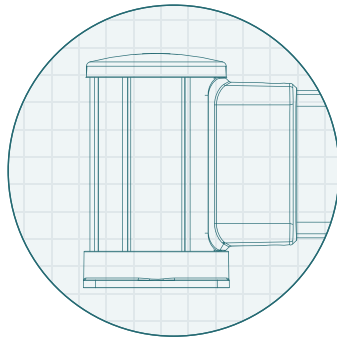

Modularity & simplicity

Our modular rails and bollards allow for damaged or worn parts to be replaced at a component level. If you need to replace any component - it is just a slide away.

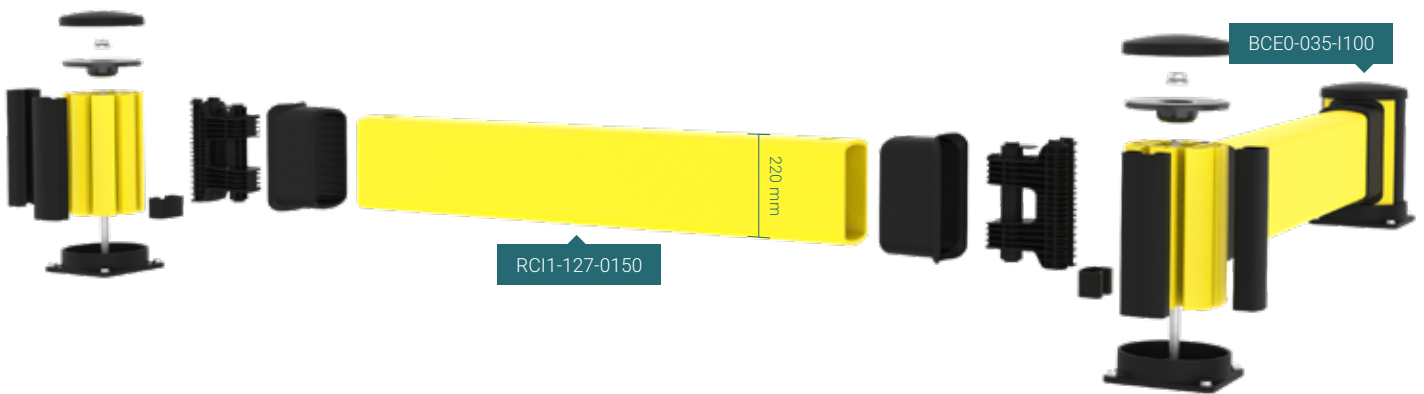

ARTICLES FOR IMPACT BARRIER

Art.No.	Product name	Colour
Posts		
BCE0-035-I100	Impact end, H=350mm	● RAL 1018 & ● RAL 9011
BCE1-035-I100	Impact end, H=350mm	● RAL 1018
BCM0-035-I100	Impact mid, H=350mm	● RAL 1018 & ● RAL 9011
BCM1-035-I100	Impact mid, H=350mm	● RAL 1018
BCC0-035-I100	Impact corner, H=350mm	● RAL 1018 & ● RAL 9011
BCC1-035-I100	Impact corner, H=350mm	● RAL 1018
Impact rails		
RCI1-027-0050	Impact rail, L=270mm C-C=500mm	● RAL 1018
RCI1-047-0070	Impact rail, L=470mm C-C=700mm	● RAL 1018
RCI1-077-0100	Impact rail, L=770mm C-C=1000mm	● RAL 1018
RCI1-127-0150	Impact rail, L=1270mm C-C=1500mm	● RAL 1018
RCI1-177-0200	Impact rail, L=1770mm C-C=2000mm	● RAL 1018
RCI1-227-0250	Impact rail, L=2270mm C-C=2500mm	● RAL 1018
RCI1-277-0300	Impact rail, L=2770mm C-C=3000mm	● RAL 1018

* Please consult the assembly manual for the complete list of all articles. Scan the QR code on page 4 to download it.



Impact High

When should you use the Impact High Barrier?

✓ Use the Impact High Barrier for high level impact protection. It is ideal for segregating light weight vehicles or defining warehouse zones.

SCAN THE CODE TO WATCH OUR ASSEMBLY VIDEO

Our **weighted forklift truck replica**, applies repeatable real-world forces to impact zones.

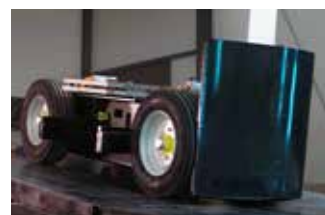

IMPACT TEST RESULTS

Area of impact	Load	90° Deflection	Force to fixings
Centre of barrier C-C as below			
2500mm	5500 J	470mm	<19.5 kN
3000mm	5200 J	520mm	<19.5 kN
Posts			
End post	2400 J	<470mm *	<19.5 kN
Mid post	2400 J	<470mm *	<19.5 kN

* Deflection of posts is significantly less than that of the rail/s and is not considered to be critical for product selection.

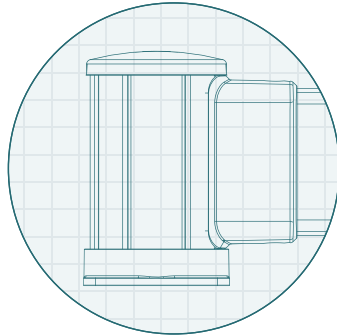

Modularity & simplicity

Our modular rails and bollards allow for damaged or worn parts to be replaced at a component level. If you need to replace any component - it is just a slide away.

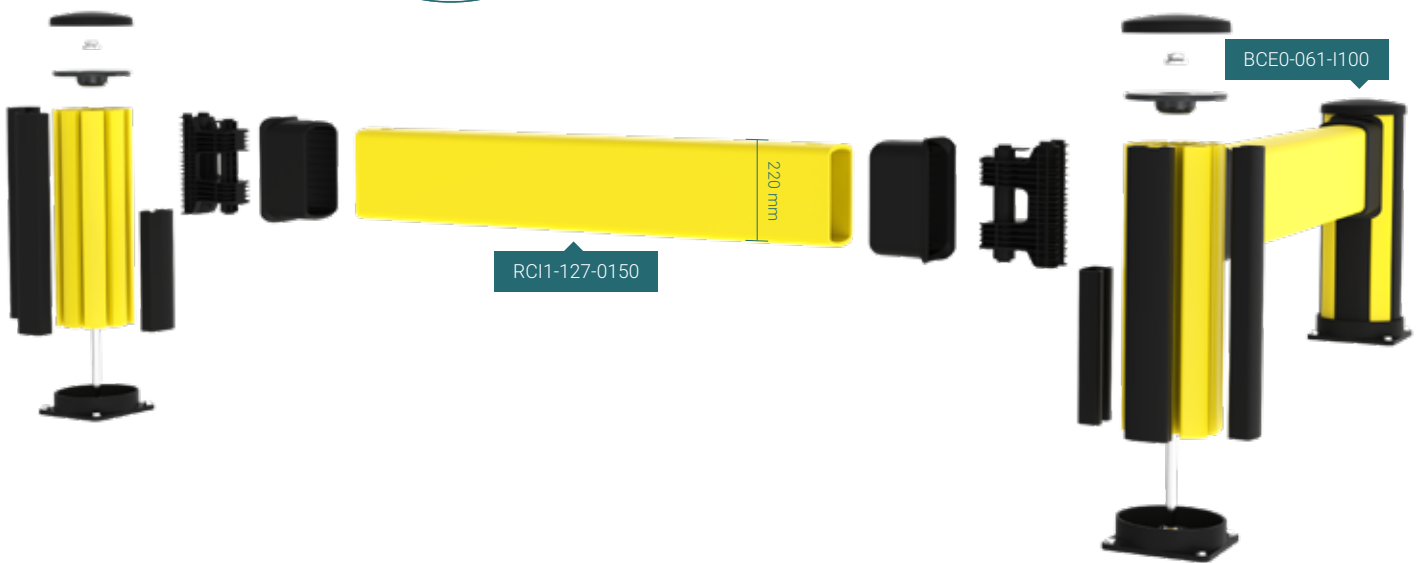

ARTICLES FOR IMPACT HIGH BARRIER

Art.No.	Product name	Colour
Posts		
BCE0-061-I100	Impact H end, H=610mm	● RAL 1018 & ● RAL 9011
BCE1-061-I100	Impact H end, H=610mm	● RAL 1018
BCM0-061-I100	Impact H mid, H=610mm	● RAL 1018 & ● RAL 9011
BCM1-061-I100	Impact H mid, H=610mm	● RAL 1018
BCC0-061-I100	Impact H corner, H=610mm	● RAL 1018 & ● RAL 9011
BCC1-061-I100	Impact H corner, H=610mm	● RAL 1018
Impact rails		
RCI1-027-0050	Impact rail, L=270mm C-C=500mm	● RAL 1018
RCI1-047-0070	Impact rail, L=470mm C-C=700mm	● RAL 1018
RCI1-077-0100	Impact rail, L=770mm C-C=1000mm	● RAL 1018
RCI1-127-0150	Impact rail, L=1270mm C-C=1500mm	● RAL 1018
RCI1-177-0200	Impact rail, L=1770mm C-C=2000mm	● RAL 1018
RCI1-227-0250	Impact rail, L=2270mm C-C=2500mm	● RAL 1018
RCI1-277-0300	Impact rail, L=2770mm C-C=3000mm	● RAL 1018

* Please consult the assembly manual for the complete list of all articles. Scan the QR code on page 4 to download it.

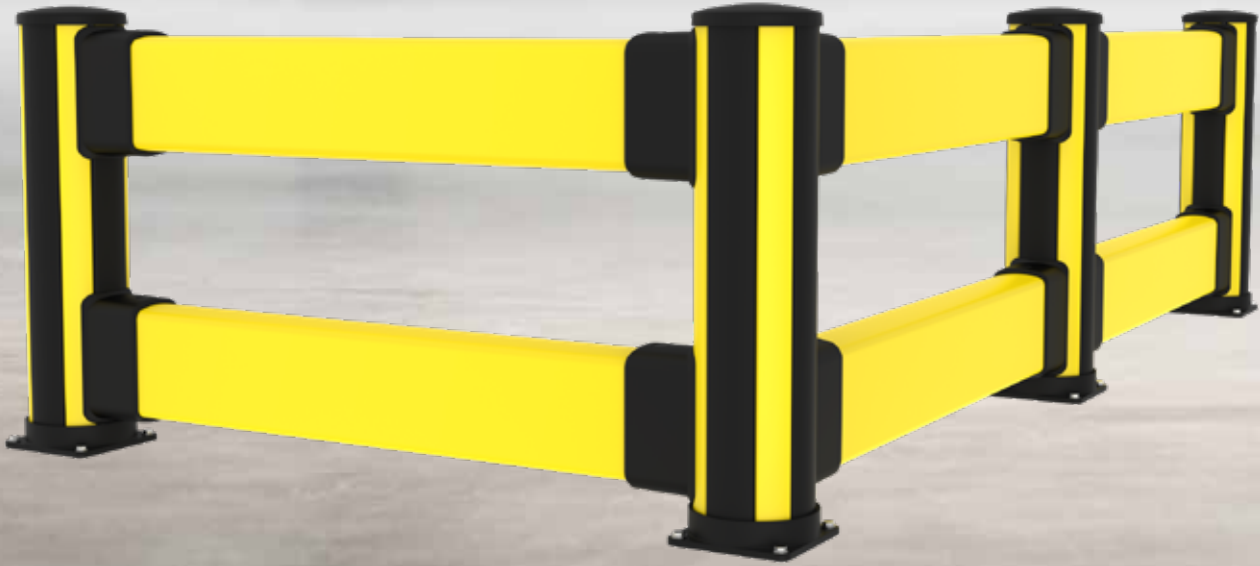

Double Impact

When should you use the Double Impact Barrier?

✓ Use the Double Impact Barrier configuration to protect structures from high level, heavy duty impacts. It is one of our strongest Impact protection configurations.

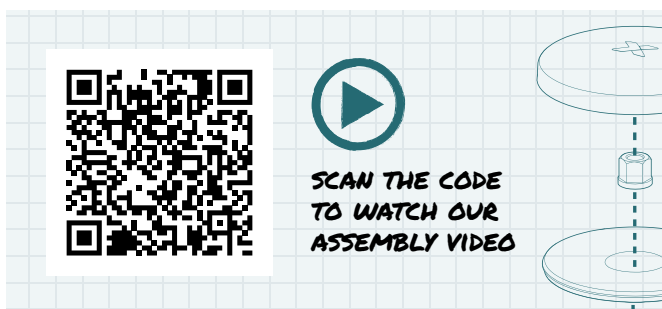

SCAN THE CODE
TO WATCH OUR
ASSEMBLY VIDEO

⚠ Our **weighted forklift truck replica**, applies repeatable real-world forces to impact zones.



IMPACT TEST RESULTS

Area of impact	Load	90° Deflection	Force to fixings
Centre of barrier C-C as below			
2500mm	6500 J	370mm	<15.5 kN
3000mm	6200 J	430mm	<15.5 kN
Posts			
End post	6100 J	<370mm *	<15.5 kN
Mid post	6100 J	<370mm *	<15.5 kN

* Deflection of posts is significantly less than that of the rail/s and is not considered to be critical for product selection.

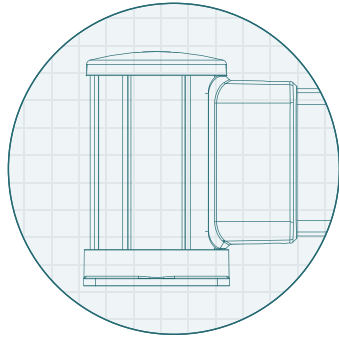

Modularity & simplicity

Our modular rails and bollards allow for damaged or worn parts to be replaced at a component level. If you need to replace any component - it is just a slide away.

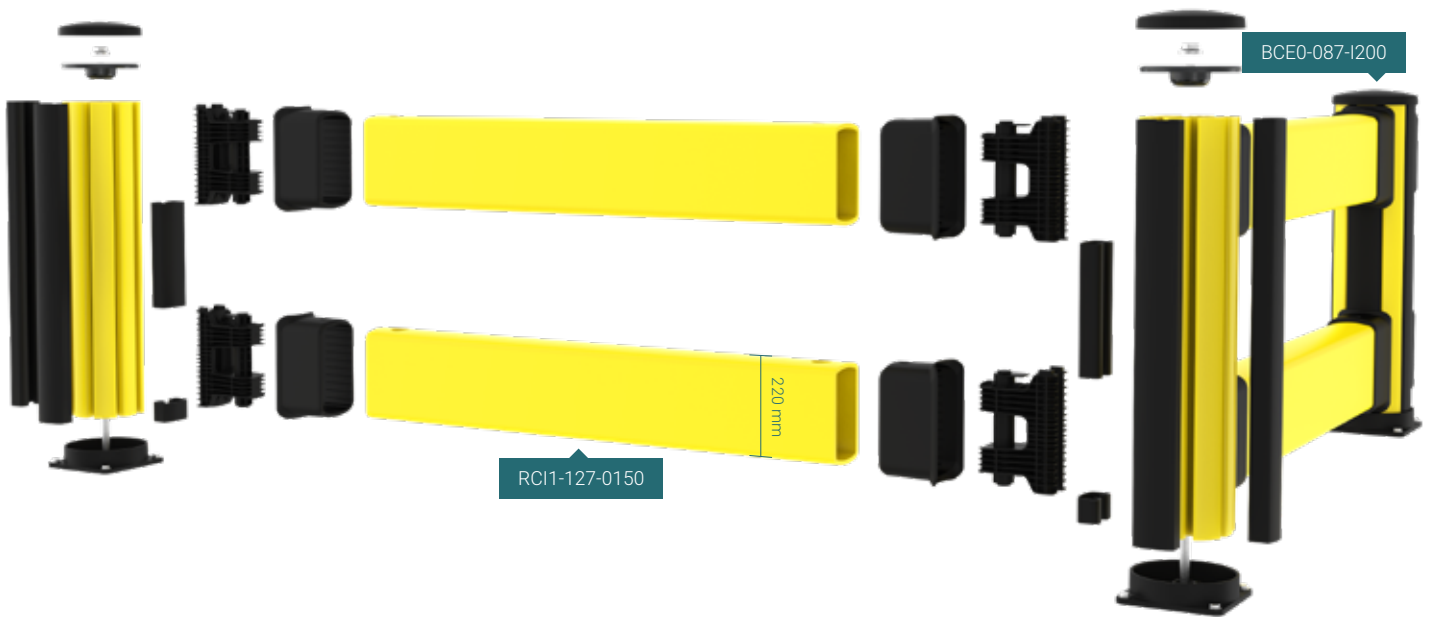

ARTICLES FOR DOUBLE IMPACT BARRIER

Art.No.	Product name	Colour
Posts		
BCE0-087-I200	Double Impact end, H=870mm	● RAL 1018 & ● RAL 9011
BCE1-087-I200	Double Impact end, H=870mm	● RAL 1018
BCM0-087-I200	Double Impact mid, H=870mm	● RAL 1018 & ● RAL 9011
BCM1-087-I200	Double Impact mid, H=870mm	● RAL 1018
BCC0-087-I200	Double Impact corner, H=870mm	● RAL 1018 & ● RAL 9011
BCC1-087-I200	Double Impact corner, H=870mm	● RAL 1018
Impact rails		
RCI1-027-0050	Impact rail, L=270mm C-C=500mm	● RAL 1018
RCI1-047-0070	Impact rail, L=470mm C-C=700mm	● RAL 1018
RCI1-077-0100	Impact rail, L=770mm C-C=1000mm	● RAL 1018
RCI1-127-0150	Impact rail, L=1270mm C-C=1500mm	● RAL 1018
RCI1-177-0200	Impact rail, L=1770mm C-C=2000mm	● RAL 1018
RCI1-227-0250	Impact rail, L=2270mm C-C=2500mm	● RAL 1018
RCI1-277-0300	Impact rail, L=2770mm C-C=3000mm	● RAL 1018

* Please consult the assembly manual for the complete list of all articles. Scan the QR code on page 4 to download it.

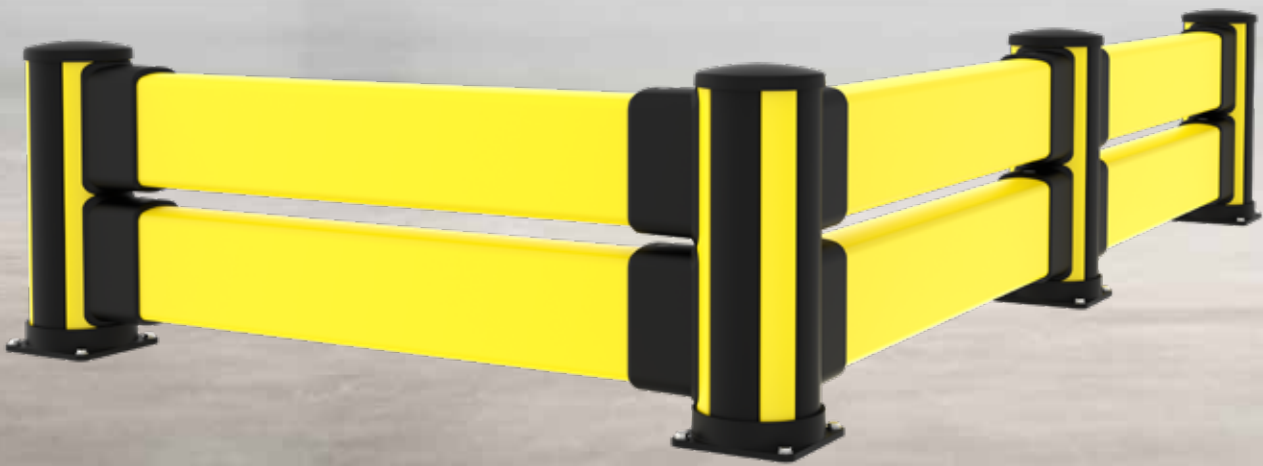

Double Impact Low

When should you use the Double Impact Low Barrier?

✓ Use the Double Impact Low Barrier configuration to protect structures from ground level, heavy duty impacts. It is one of our strongest Impact protection configurations. It is ideal for protecting pallet racking.

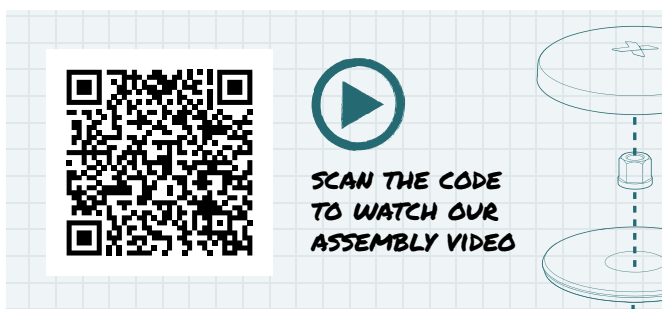

! Our **weighted forklift truck replica**, applies repeatable real-world forces to impact zones.



IMPACT TEST RESULTS

Area of impact	Load	90° Deflection	Force to fixings
Centre of barrier C-C as below			
2500mm	7000 J	390mm	<15.5 kN
3000mm	6700 J	440mm	<15.5 kN
Posts			
End post	5800 J	<390mm *	<15.5 kN
Mid post	5800 J	<390mm *	<15.5 kN

* Deflection of posts is significantly less than that of the rail/s and is not considered to be critical for product selection.

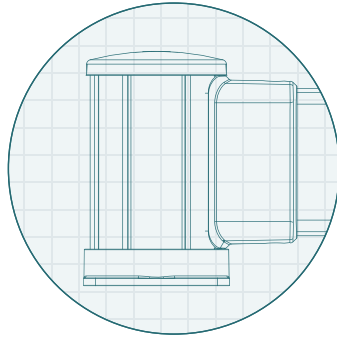

Modularity & simplicity

Our modular rails and bollards allow for damaged or worn parts to be replaced at a component level. If you need to replace any component - it is just a slide away.

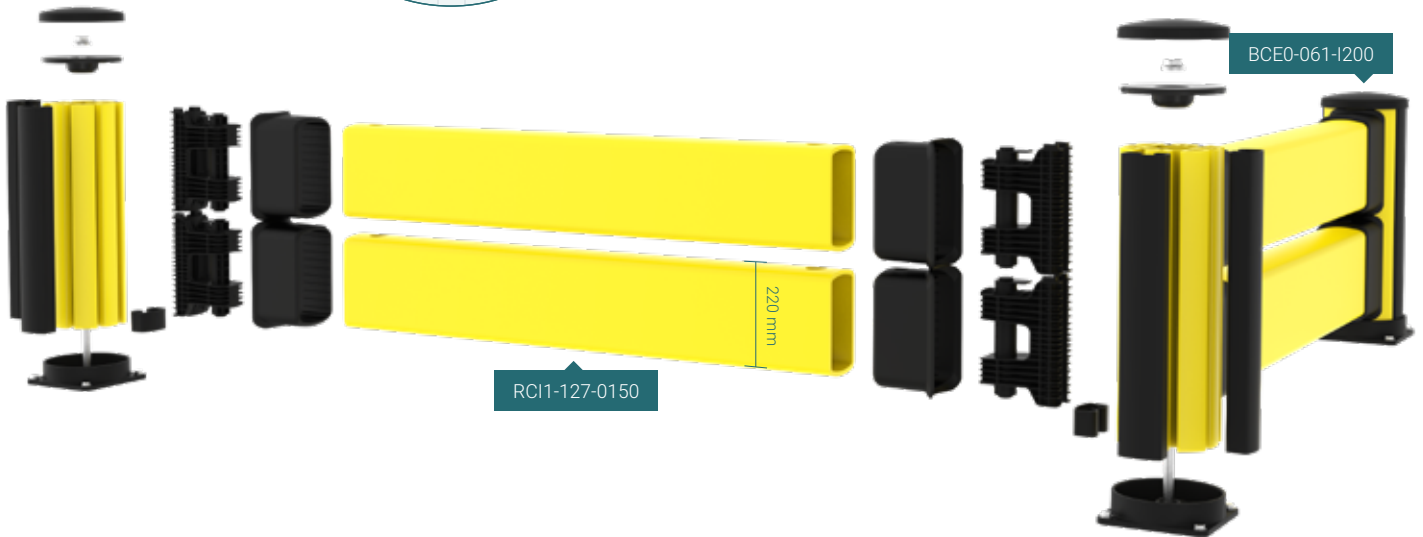

ARTICLES FOR DOUBLE IMPACT LOW BARRIER

Art.No.	Product name	Colour
Posts		
BCE0-061-I200	Double Impact L end, H=610mm	● RAL 1018 & ● RAL 9011
BCE1-061-I200	Double Impact L end, H=610mm	● RAL 1018
BCM0-061-I200	Double Impact L mid, H=610mm	● RAL 1018 & ● RAL 9011
BCM1-061-I200	Double Impact L mid, H=610mm	● RAL 1018
BCC0-061-I200	Double Impact L corner, H=610mm	● RAL 1018 & ● RAL 9011
BCC1-061-I200	Double Impact L corner, H=610mm	● RAL 1018
Impact rails		
RCI1-027-0050	Impact rail, L=270mm C-C=500mm	● RAL 1018
RCI1-047-0070	Impact rail, L=470mm C-C=700mm	● RAL 1018
RCI1-077-0100	Impact rail, L=770mm C-C=1000mm	● RAL 1018
RCI1-127-0150	Impact rail, L=1270mm C-C=1500mm	● RAL 1018
RCI1-177-0200	Impact rail, L=1770mm C-C=2000mm	● RAL 1018
RCI1-227-0250	Impact rail, L=2270mm C-C=2500mm	● RAL 1018
RCI1-277-0300	Impact rail, L=2770mm C-C=3000mm	● RAL 1018

* Please consult the assembly manual for the complete list of all articles. Scan the QR code on page 4 to download it.



Pedestrian

When should you use the Pedestrian Barrier?

✔ Use the Pedestrian barrier configuration to define pedestrian routes and protect from light duty impacts.

SCAN THE CODE TO WATCH OUR ASSEMBLY VIDEO

⚠ Our **weighted forklift truck replica**, applies repeatable real-world forces to impact zones.

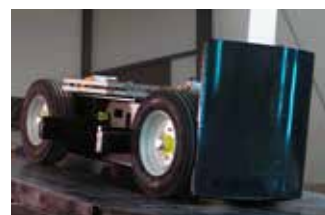

IMPACT TEST RESULTS

Area of impact	Load	90° Deflection	Force to fixings
Centre of barrier C-C as below			
2500mm	5400 J	550mm	<15.5 kN
3000mm	5000 J	630mm	<15.5 kN
Posts			
End post	1900 J	<550mm *	<15.5 kN
Mid post	1900 J	<550mm *	<15.5 kN

* Deflection of posts is significantly less than that of the rail/s and is not considered to be critical for product selection.

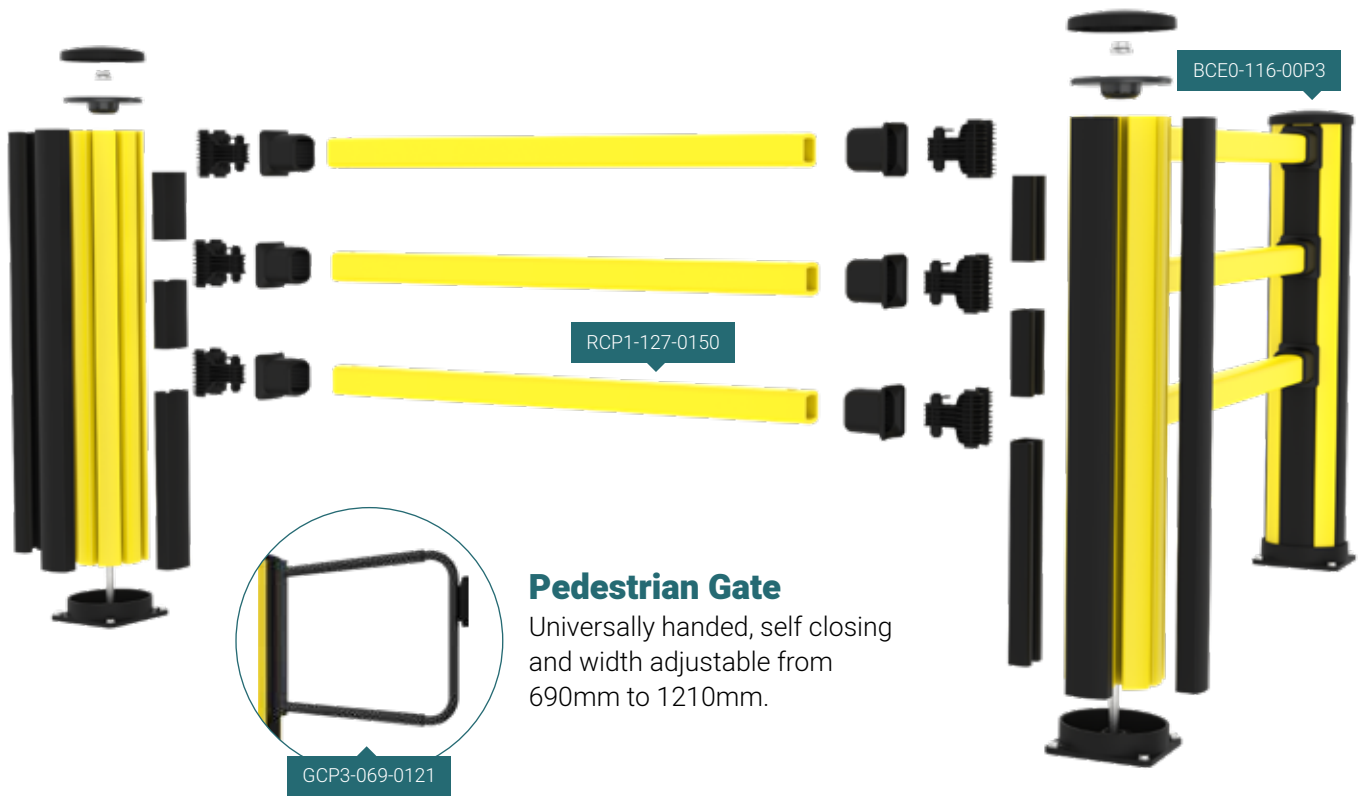

Pedestrian Gate

Universally handed, self closing and width adjustable from 690mm to 1210mm.

ARTICLES FOR PEDESTRIAN BARRIER

Art.No.	Product name	Colour
Posts		
BCE0-116-00P3	Pedestrian end, H=1160mm	● RAL 1018 & ● RAL 9011
BCE1-116-00P3	Pedestrian end, H=1160mm	● RAL 1018
BCM0-116-00P3	Pedestrian mid, H=1160mm	● RAL 1018 & ● RAL 9011
BCM1-116-00P3	Pedestrian mid, H=1160mm	● RAL 1018
BCC0-116-00P3	Pedestrian corner, H=1160mm	● RAL 1018 & ● RAL 9011
BCC1-116-00P3	Pedestrian corner, H=1160mm	● RAL 1018
Hand rails		
RCP1-027-0050	Hand rail, L=270mm C-C=500mm	● RAL 1018
RCP1-047-0070	Hand rail, L=470mm C-C=700mm	● RAL 1018
RCP1-077-0100	Hand rail, L=770mm C-C=1000mm	● RAL 1018
RCP1-127-0150	Hand rail, L=1270mm C-C=1500mm	● RAL 1018
RCP1-177-0200	Hand rail, L=1770mm C-C=2000mm	● RAL 1018
RCP1-227-0250	Hand rail, L=2270mm C-C=2500mm	● RAL 1018
RCP1-277-0300	Hand rail, L=2770mm C-C=3000mm	● RAL 1018
Gate		
GCP3-069-0121	Pedestrian gate, 690-1210mm C-C 980-1500mm	● RAL 9011

* Please consult the assembly manual for the complete list of all articles. Scan the QR code on page 4 to download it.



Pedestrian + Impact

When should you use the Pedestrian + Impact Barrier?

✓ Use the Pedestrian + Impact barrier configuration to protect walkways from medium duty vehicles where there is an increased risk of ground level impacts.

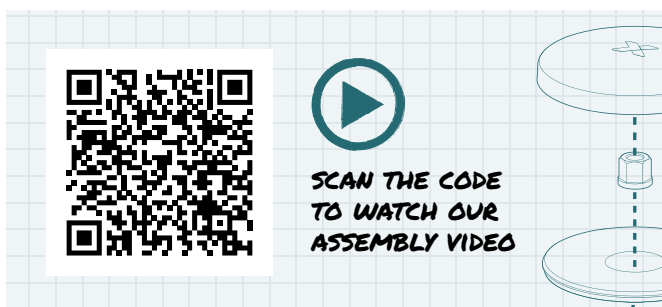

⚠ Our **weighted forklift truck replica**, applies repeatable real-world forces to impact zones.



IMPACT TEST RESULTS

Area of impact	Load	90° Deflection	Force to fixings
Centre of barrier C-C as below			
2500mm	6700 J	440mm	<15 kN
3000mm	6200 J	440mm	<15 kN
Posts			
End post	6000 J	<440mm *	<15 kN
Mid post	6000 J	<440mm *	<15 kN

* Deflection of posts is significantly less than that of the rail/s and is not considered to be critical for product selection.

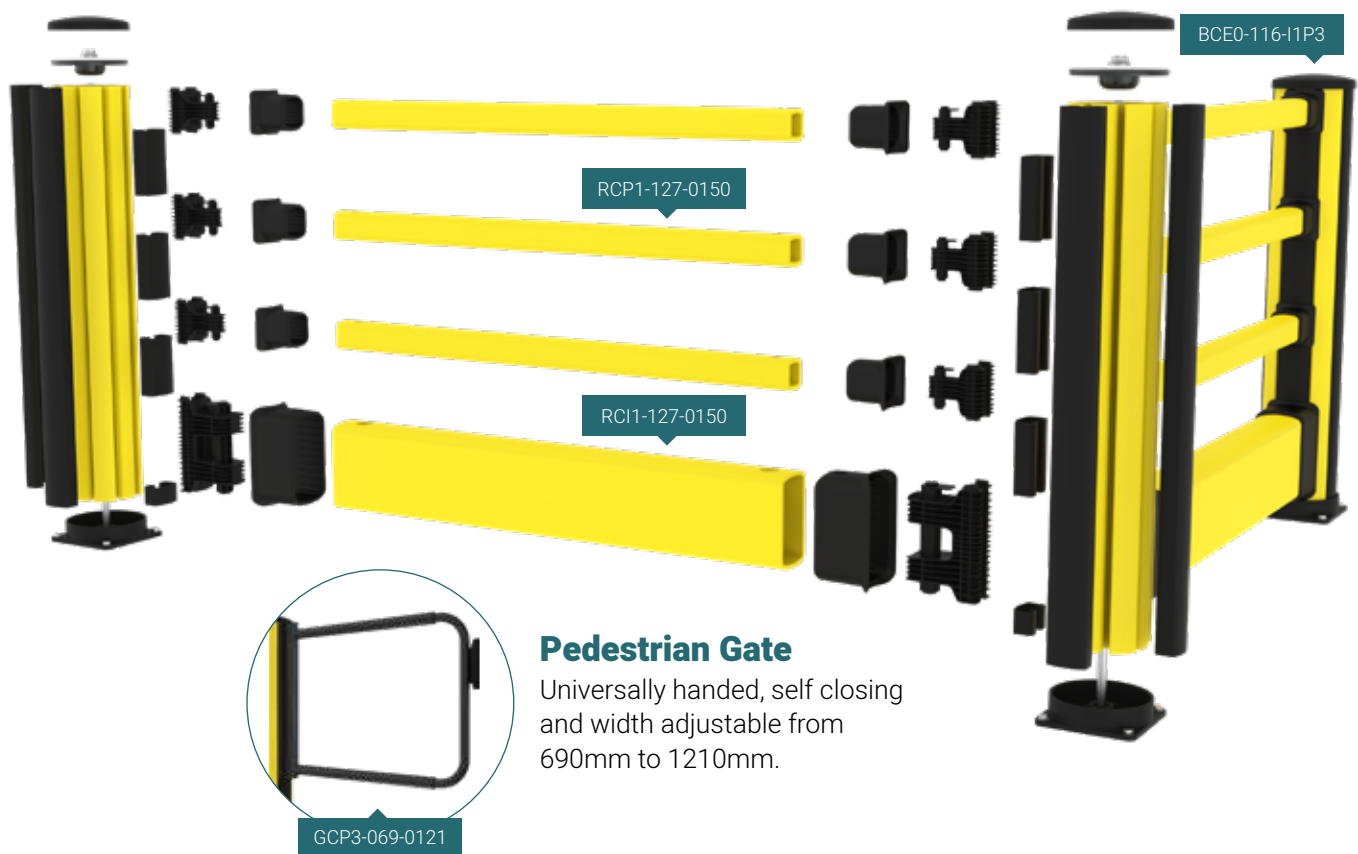

Pedestrian Gate

Universally handed, self closing and width adjustable from 690mm to 1210mm.

ARTICLES FOR PEDESTRIAN + IMPACT BARRIER		
Art.No.	Product name	Colour
Posts		
BCE0-116-I1P3	Pedestrian + Impact end, H=1160mm	● RAL 1018 & ● RAL 9011
BCE1-116-I1P3	Pedestrian + Impact end, H=1160mm	● RAL 1018
BCM0-116-I1P3	Pedestrian + Impact mid, H=1160mm	● RAL 1018 & ● RAL 9011
BCM1-116-I1P3	Pedestrian + Impact mid, H=1160mm	● RAL 1018
BCC0-116-I1P3	Pedestrian + Impact corner, H=1160mm	● RAL 1018 & ● RAL 9011
BCC1-116-I1P3	Pedestrian + Impact corner, H=1160mm	● RAL 1018
Impact rails		
RCI1-027-0050	Impact rail, L=270mm C-C=500mm	● RAL 1018
RCI1-047-0070	Impact rail, L=470mm C-C=700mm	● RAL 1018
RCI1-077-0100	Impact rail, L=770mm C-C=1000mm	● RAL 1018
RCI1-127-0150	Impact rail, L=1270mm C-C=1500mm	● RAL 1018
RCI1-177-0200	Impact rail, L=1770mm C-C=2000mm	● RAL 1018
RCI1-227-0250	Impact rail, L=2270mm C-C=2500mm	● RAL 1018
RCI1-277-0300	Impact rail, L=2770mm C-C=3000mm	● RAL 1018
Hand rails		
RCP1-027-0050	Hand rail, L=270mm C-C=500mm	● RAL 1018
RCP1-047-0070	Hand rail, L=470mm C-C=700mm	● RAL 1018
RCP1-077-0100	Hand rail, L=770mm C-C=1000mm	● RAL 1018
RCP1-127-0150	Hand rail, L=1270mm C-C=1500mm	● RAL 1018
RCP1-177-0200	Hand rail, L=1770mm C-C=2000mm	● RAL 1018
RCP1-227-0250	Hand rail, L=2270mm C-C=2500mm	● RAL 1018
RCP1-277-0300	Hand rail, L=2770mm C-C=3000mm	● RAL 1018
Gate		
GCP3-069-0121	Pedestrian gate, 690-1210mm C-C 980-1500mm	● RAL 9011

* Please consult the assembly manual for the complete list of all articles. Scan the QR code on page 4 to download it.



Pedestrian + Impact High

When should you use the Pedestrian + Impact High Barrier?

✓ Use the Pedestrian + Impact high barrier configuration to protect walkways from medium duty vehicles where there is a reduced risk of ground level impacts.

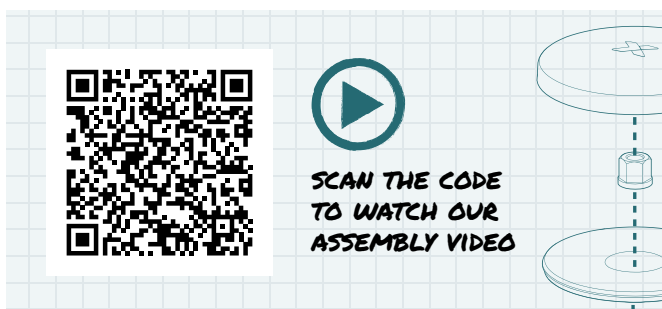

! Our **weighted forklift truck replica**, applies repeatable real-world forces to impact zones.



IMPACT TEST RESULTS

Area of impact	Load	90° Deflection	Force to fixings
Centre of barrier C-C as below			
2500mm	7250 J	520mm	<15.5 kN
3000mm	6000 J	530mm	<15.5 kN
Posts			
End post	1850 J	<520mm *	<15.5 kN
Mid post	2450 J	<520mm *	<15.5 kN

* Deflection of posts is significantly less than that of the rail/s and is not considered to be critical for product selection.

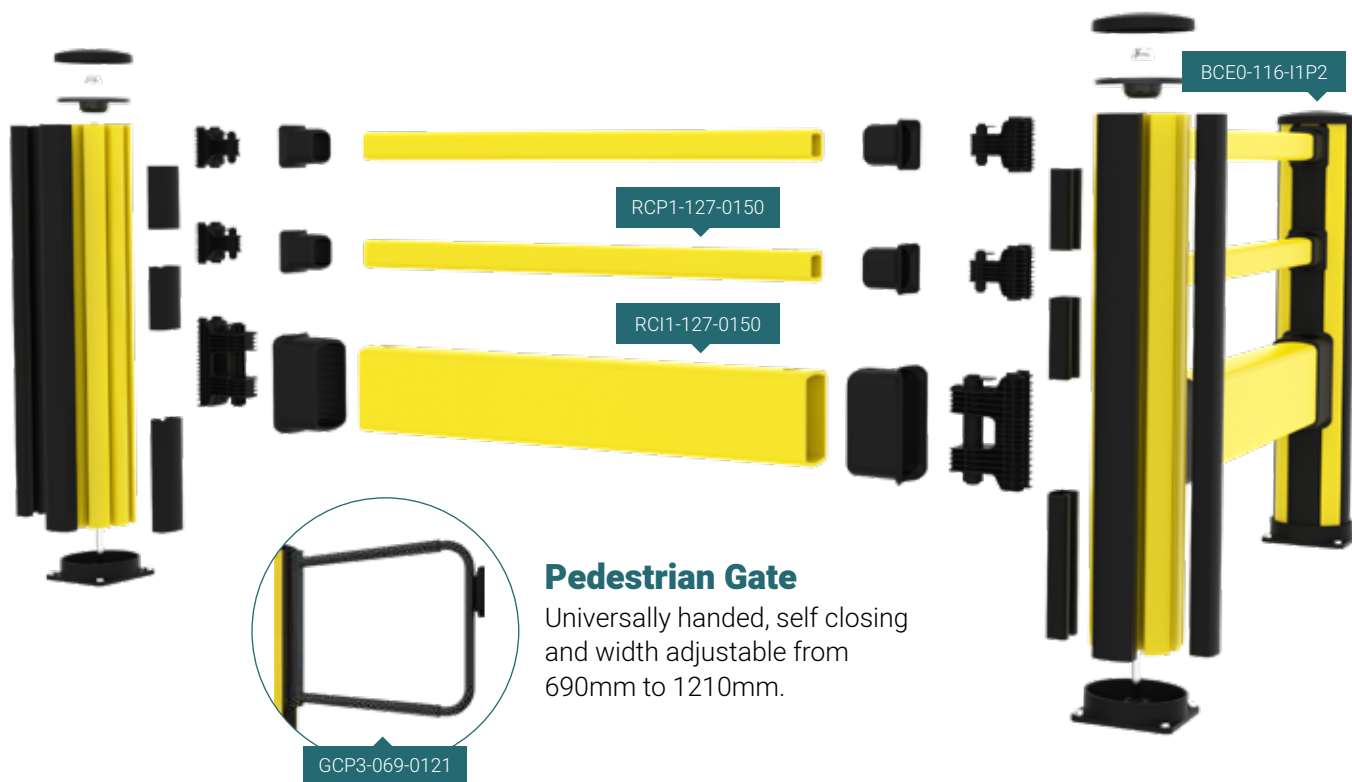

Pedestrian Gate

Universally handed, self closing and width adjustable from 690mm to 1210mm.

ARTICLES FOR PEDESTRIAN + IMPACT HIGH BARRIER		
Art.No.	Product name	Colour
Posts		
BCE0-116-1P2	Pedestrian + Impact H end, H=1160mm	● RAL 1018 & ● RAL 9011
BCE1-116-1P2	Pedestrian + Impact H end, H=1160mm	● RAL 1018
BCM0-116-1P2	Pedestrian + Impact H mid, H=1160mm	● RAL 1018 & ● RAL 9011
BCM1-116-1P2	Pedestrian + Impact H mid, H=1160mm	● RAL 1018
BCC0-116-1P2	Pedestrian + Impact H corner, H=1160mm	● RAL 1018 & ● RAL 9011
BCC1-116-1P2	Pedestrian + Impact H corner, H=1160mm	● RAL 1018
Impact rails		
RCI1-027-0050	Impact rail, L=270mm C-C=500mm	● RAL 1018
RCI1-047-0070	Impact rail, L=470mm C-C=700mm	● RAL 1018
RCI1-077-0100	Impact rail, L=770mm C-C=1000mm	● RAL 1018
RCI1-127-0150	Impact rail, L=1270mm C-C=1500mm	● RAL 1018
RCI1-177-0200	Impact rail, L=1770mm C-C=2000mm	● RAL 1018
RCI1-227-0250	Impact rail, L=2270mm C-C=2500mm	● RAL 1018
RCI1-277-0300	Impact rail, L=2770mm C-C=3000mm	● RAL 1018
Hand rails		
RCP1-027-0050	Hand rail, L=270mm C-C=500mm	● RAL 1018
RCP1-047-0070	Hand rail, L=470mm C-C=700mm	● RAL 1018
RCP1-077-0100	Hand rail, L=770mm C-C=1000mm	● RAL 1018
RCP1-127-0150	Hand rail, L=1270mm C-C=1500mm	● RAL 1018
RCP1-177-0200	Hand rail, L=1770mm C-C=2000mm	● RAL 1018
RCP1-227-0250	Hand rail, L=2270mm C-C=2500mm	● RAL 1018
RCP1-277-0300	Hand rail, L=2770mm C-C=3000mm	● RAL 1018
Gate		
GCP3-069-0121	Pedestrian gate, 690-1210mm C-C 980-1500mm	● RAL 9011

* Please consult the assembly manual for the complete list of all articles. Scan the QR code on page 4 to download it.

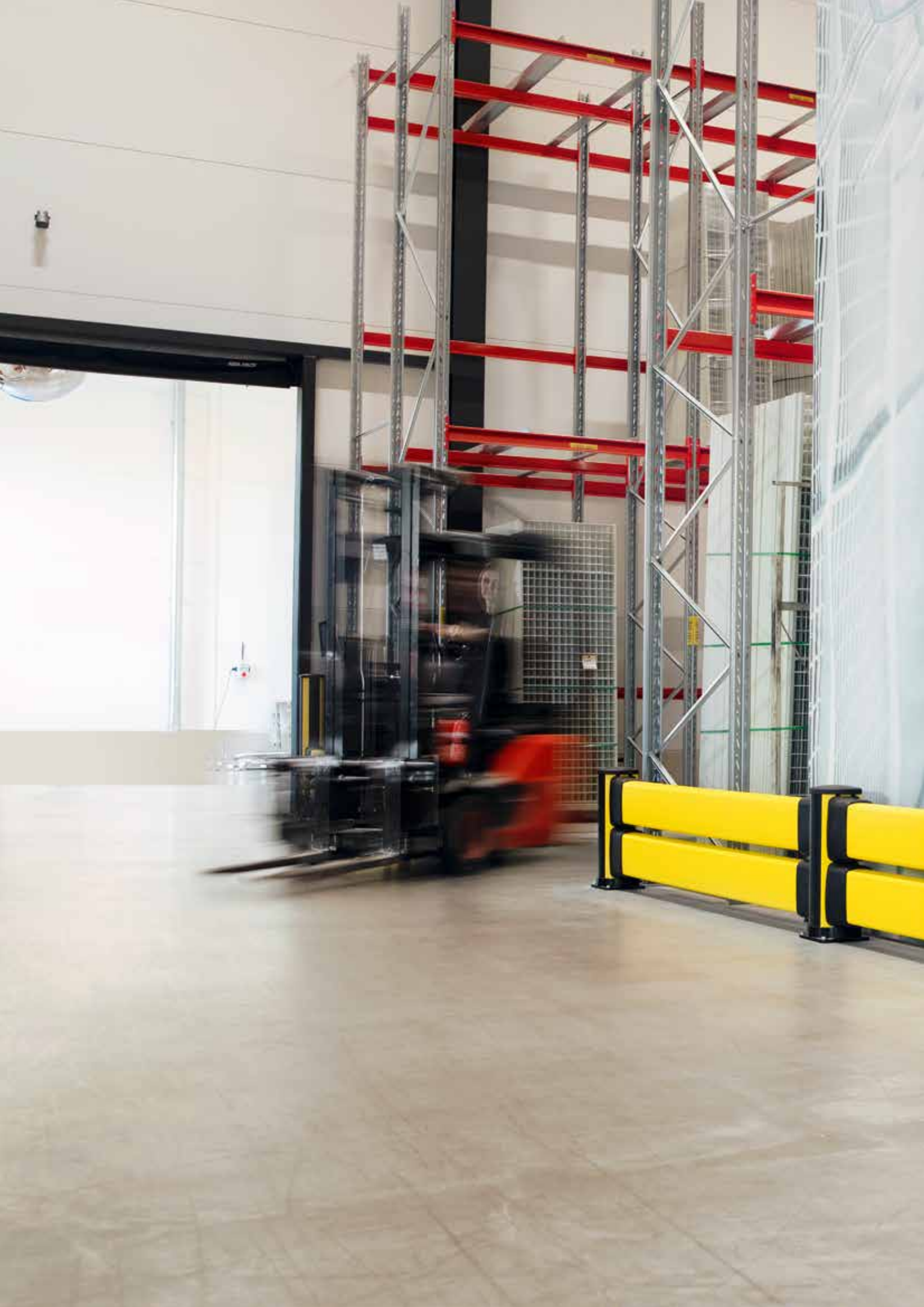





READ THE BROCHURE
ONLINE BY SCANNING
THE QR CODE



AXELENT
X-Protect
TECHNICAL



AXELENT · AXELENT ENGINEERING · AXELENT SOLUTIONS · AXELENT SAFE-X

AXELENT AB · BOX 1 · KÄVSJÖVÄGEN 17 · 335 04 HILLERSTORP, SWEDEN
0370-37 37 30 · GLOBALSALES@AXELENT.COM · WWW.AXELENT.COM

EN2209_1.0_SACH

