

New! X-Store 2.0

- ✓ New **fast and unique way to attach panels** to posts
- ✓ **Wide range of locks and doors** (same range as for Axellent X-Guard)
- ✓ **Remove a panel without affecting** the adjacent panels
- ✓ **Build right up to the ceiling**
- ✓ **In stock from January 2020**
- ✓ Available in **SnapperWorks from January 2020**
- ✓ **Modular concept** – custom height and width
- ✓ New **floor fitting design** – combine with **posts** of standard height for **cost efficiency**

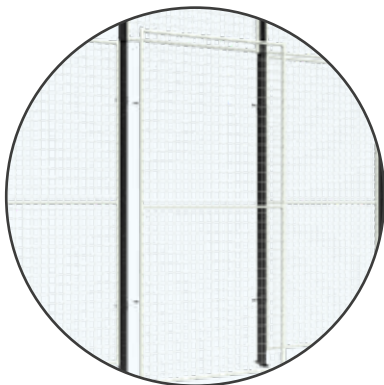

Remove/move a panel without affecting the adjacent panels

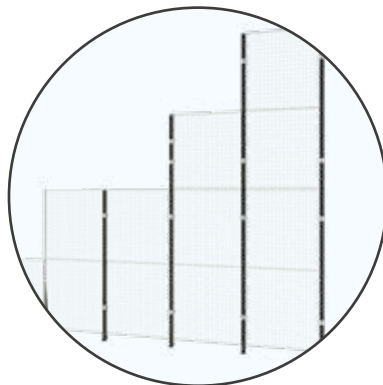

X-Store 2.0 grows with you – in both height and width

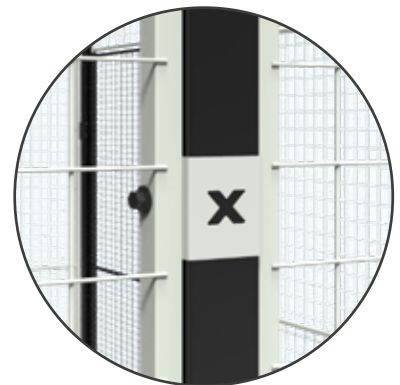

Attach panels to posts quickly and with great results

More new features! X-Store 2.0 X-Store Ceiling

- ✓ **Flexible posts** – build in 3 different directions, including corners
- ✓ **Easily adjust the height** of the panels
- ✓ **New joint** for easier and stronger vertical constructions
- ✓ **Clearly marked entrances and exits** with different wall and door panel colours
- ✓ **Made-to-measure installations** with cutting kits and adjustable panel inserts

- ✓ **Max. width 6 m**
- ✓ **Unlimited length**
- ✓ Available in **SnapperWorks** from **January 2020**

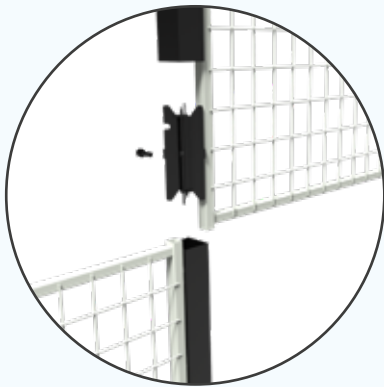

Building higher panel walls is easy

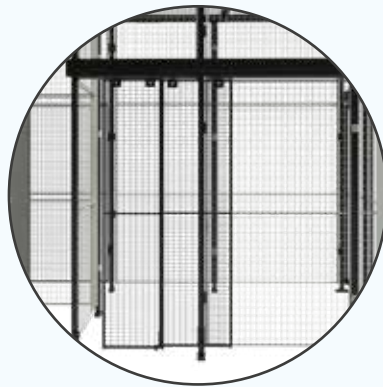

Show the way with colour. The door panel is black while the mesh walls are light grey

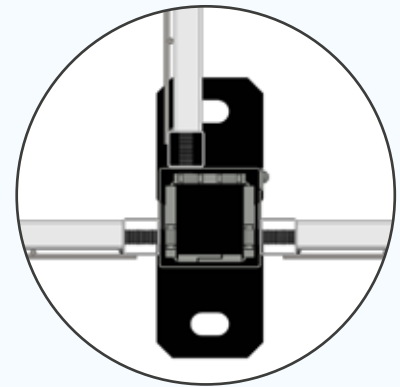

Attach panels to posts quickly and with great results

Specifications	Mesh panels, Light grey (RAL 9018)	
X-Store 2.0	Height, mm	Width, mm
Vertical tubing	19x19	2 200
Horizontal tubing	15x15	1 100
Posts	50x50, 70x70 or low floor fitting	250, 400, 700, 1 000, 1 200 or 1 500
Vertical wires	Ø 3	
Horizontal wires	Ø 2.5	
Mesh aperture	50x60	
Coating	Phosphate/Epoxy paint	
Colour, mesh panel	Light grey RAL 9018	
Colour, post	Black RAL 9011	

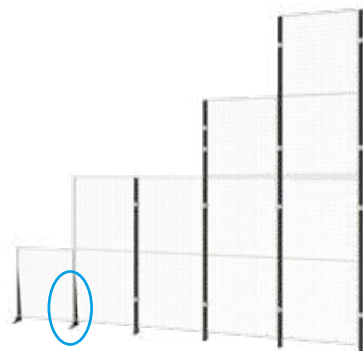

Build up to 4.5 metres in height with no additional reinforcement

New floor fitting design – combine with posts of standard height for cost efficiency

